

INSTALLATION, MAINTENANCE AND OPERATING INSTRUCTION MANUAL

For ACTUATORS EDITION 2010:

- **DR/SC** • **Double acting "DR" and Spring return "SC"** • **90°-180° Stroke**

1. GENERAL	P.0901e	6. MAINTENANCE INSTRUCTIONS	P.0903e
2. WARNING	P.0901e	7. STORAGE INSTRUCTIONS	P.0907e
3. WORKING CONDITIONS AND TECHNICAL DATA	P.0901e	8. LIFTING AND HANDLING	P.0907e
4. OPERATING FUNCTION AND DIRECTION OF ROTATION	P.0902e	9. NOTES REGARDING THE FLANGE CONNECTION	P.0907e
5. INSTALLATION INSTRUCTIONS	P.0902e		

1. GENERAL

This instruction manual contains important information regarding the installation, operation, maintenance and storage for BSA Armaturen rack and pinion pneumatic actuators. Please read these instructions carefully and keep them for future reference. It is important that the use and maintenance of the actuator is made only by properly trained personnel.

2. WARNING

- Do not operate the actuator using inflammable, oxidizing, corrosive, explosive or unstable gases or liquids (use only not dangerous fluids – group 2 according to 97/26/EC directive). Moreover, for actuators installed in potentially explosive zones, make sure that the internal parts of the actuator do not come into contact with the external atmosphere.
- Referring to the Machinery Directive 2006/46/EC, the actuators can be classified as "PARTLY COMPLETED MACHINERY" (see the DECLARATION OF INCORPORATION). Therefore the actuator can not put into service until the machinery and/or the system, where the actuator is incorporated, will be declared in compliance with the requirements of the Directive 2006/42/EC.
- BSA actuators are designed, produced and classified according to the ATEX Directive 94/9/EC (see actuator label and safety instructions). The use of the actuators in potential explosive atmosphere zones has to comply with the ATEX classification indicated on the actuator label and according to the ATEX safety instructions.
- The use, the installation and the maintenance of the BSA actuators must be made by adequately trained personnel. For the use, installation and maintenance of Air Torque actuators it is recommended to comply to the safety notice and to use proper equipment to protect health and prevent accidents.
- It is important that the actuator is used only within the working limits indicated in the technical specifications.
- Do not operate the actuator over temperature limits: this could damage internal and external components (disassembly of spring return actuator may become dangerous).
- Do not operate the actuator over pressure limits: this could damage internal parts as well as cause damage to the housing and end-caps.
- Do not use the actuator in corrosive environments with incorrect protection: this could damage the internal and external parts.
- Do not disassemble individual spring cartridges, this may result in personal injury. If maintenance to springs is necessary, send them to BSA Armaturen
- Close and disconnect all air supply lines and make sure that air connections are vented during maintenance and installation on valve.
- Do not disassemble the actuator or remove end caps while the actuator is pressurized.
- The 4TH GENERATION Upgrade Series actuators are designed to be used only on valves.
- Before installing the actuator onto the valve make sure that the rotation direction and the position indicator are in the correct position.
- If the actuator is incorporated in a system or used within safety devices or circuits, the customer shall ensure that the national and local safety laws and regulations are observed.

3. WORKING CONDITIONS AND TECHNICAL DATA

- Operating media:
Dry or lubricated air or inert gases, provided that they are compatible with the actuator internal parts and lubricant. The operating media must have a dew point equal to -20°C (-4°F) or at least 10°C below the ambient temperature. The maximum particle size contained into the operating media must not exceed 30 µm.
- Supply pressure:
The maximum supply pressure is 8 bar (116 Psi), only for AT801U it is 7 bar (101,5 Psi).
For double acting and spring return actuators the working pressure is from 2,5 bar (36 Psi) to 8 bar (116 Psi).
- Operating temperature:
=> "Standard" actuators from -40°C (-40°F) to +80°C (+176°F)
=> Actuators for high temperature "HT" from -15°C (+5°F) to +150°C (+300°F)
=> Actuators for extreme low temperature "LLT" from -55°C (-67°F) to +80°C (+176°F)
Caution: for low and high temperature service, special grease and special components are required. Please contact BSA Armaturen. Working at high or low temperature can affect the life and the output torque of the actuator.
- Operating time (see technical data sheet):
Caution: the operating time depends on several factors such as supply pressure, supply system capacity (pipe diameter, flow capacity of pneumatic accessories), valve type, valve torque and figures, applied safety factor, cycle frequency, temperature, etc.
- Rotation and stroke adjustment (see technical data sheet):
For standard actuators (90° rotation), 120° actuators (120° rotation), 135° actuators (135° rotation) and 180° actuators (180° rotation).
Stroke adjustment at 0°(closed pistons): +15°max/ -5°. Stroke adjustment at 90°, 120°, 135° and 180°(open pistons): +5°/-15°max. For actuator AT045U the stroke adjustment at 90° (open pistons) is available only on request.
- Lubrication:
The actuators are factory lubricated for the life of the actuator in normal working conditions.
The standard lubricant type GSTD is suitable for use from -40°C (-40°F) to +80°C (+176°F).
For extreme low temperature (LLT) and high temperature (HT) service, special grease is required: please contact BSA Armaturen.
- Construction: Rack and pinion actuator design suitable for both indoor or outdoor installations.
- Protection and corrosion resistance:
All the actuators are supplied with corrosion protection for normal environments. For corrosion resistance of the different types of protection see technical data sheet. Before installing the actuator in aggressive environment, ensure that the selected protection level is suitable.
- Actuator designation and marking (see technical data sheets):
The actuator type, size, operating pressure, output torque, direction of rotation, spring action, operating temperature and type of connections/interfaces are determined by designation.
- All BSA Armaturen actuators are supplied with an identification label showing the serial number and all necessary information on use, service, operation and product designation. Where applicable, the label indicates the classification according to ATEX Directive 94/9/EC.

4. OPERATING FUNCTION AND DIRECTION OF ROTATION

The actuator is a pneumatic device for remote operation of industrial valves. The operation (90°, 120°, 135° or 180° rotation) may be activated by different methods:

- Direct mounting of solenoid valve (5/2 for double acting, 3/2 for spring return) to pressure connections 2 and 4, connected to supply and control lines.
- Screwed connection (to pressure connections 2 and 4) with air lines from separate control cabinet. The standard rotation (when port 4 is pressurized or for spring action) is clockwise to close. When port 2 is pressurized, counter-clockwise rotation is obtained.

BSA actuators can be supplied with different types of assembly/rotation direction depending on the type of required operation and/or installation, see technical data sheets.

Double Acting operation function (standard rotation type "ST") TOP View

Air supplied to port 2 forces the pistons towards the actuator end caps. A counter-clockwise rotation is achieved. Exhaust air exits from Port 4.

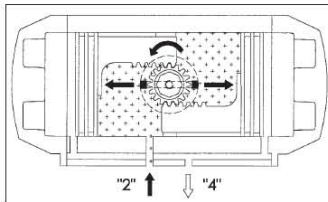

Air supplied to Port 4 forces the pistons inward. A clockwise rotation is achieved. Exhaust air exits from Port 2.

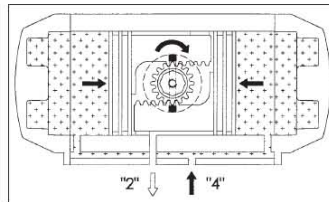

Single Acting operation function (standard rotation type "ST") TOP View

Air supplied to Port "2" forces the pistons toward the actuator end caps, compressing the springs. A counter-clockwise rotation is achieved. Exhaust air exits from Port 4.

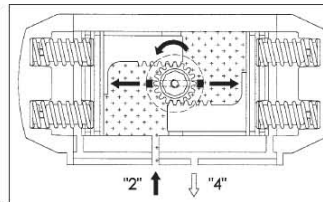

The loss of air pressure (air or electric failure) at Port "2" allows the springs to force the pistons inward. A clockwise rotation is achieved. Exhaust air exits from Port 2.

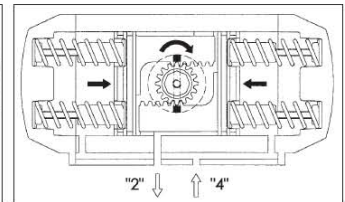

5. ACTUATOR INSTALLATION INSTRUCTIONS

The BSA actuator is a pneumatic device for the remote operation of industrial valves. The actuator will operate through 90°, 120°, 135° and 180° rotation permitting the opening and closing of many types of valves up to 180° rotation.

All the necessary technical information to install the actuator correctly and safely onto a valve i.e.: Dimensions, Output torque, Supply pressure, Air volume, Stroke adjustment, Operating time, Operating temperature, Direction of rotation and Weight is stated clearly on the Actuator label, in the catalogue and technical data sheets. Please read all technical information before proceeding with the actuator installation.

5.1 Important safety notice!

- For safety reasons, the actuator must not be pressurized at any time during installation as injury may result.
- The utmost cleanliness is required during air supply connection to the actuator i.e. the connecting pipe thread, fittings and seals must be clean and dirt-free.
- When fitting accessories onto the actuators, assemble them in such a way that the emergency control of the solenoid valve and the top of the drive shaft are easily accessible, should emergency manual operations be required.
- Before fitting onto the valve, make sure that the actuator/valve are correctly orientated, depending upon which direction of rotation is required.
- For spring return actuators, avoid that dangerous and/or corrosive substances in the working environment enter into the external chambers by using adequate filters and/or solenoid valves.
- Remove plugs from actuator air connections during installation and operation. Protect the air connections of actuators not being used immediately.

5.2 Interfaces for actuator control and connections, figure A:

5.3 Assembly of accessories: Solenoid valves and switchboxes, figure B:

- Solenoid valve mounting:
Before mounting a solenoid valve, ensure that the actuator is in its normal position (closed position) with pistons inward.
For standard rotation type "ST" (clockwise to close) assembly: the groove on the drive shaft or on the position indicator 2 must be horizontal to the longitudinal axis of the actuator in closed position.
Fit the solenoid valve 4 onto the actuator 3 using the provided screws (max. tightening torque see table).
- Switchbox mounting:
Fit the switchbox and bracket 1 onto the actuator 3 using four provided screws (max. tightening torque see table).

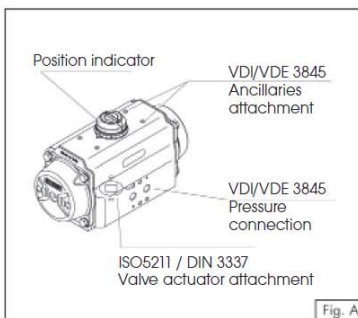

Fig. A

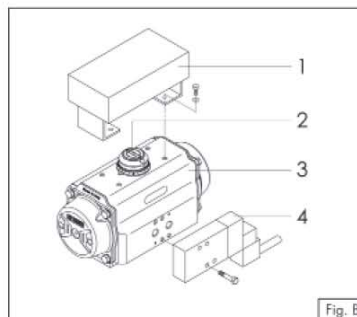

Fig. B

Tightening torque table:

M..	Nm
M5	5 > 6
M6	10 > 11
M8	23 > 25
M10	48 > 52
M12	82 > 86
M14	132 > 138
M16	200 > 210
M20	390 > 410
M24	675 > 705
M30	1340 > 1400

5.4 Assembly of valve figure C:

Before proceeding with the assembly of the actuator onto the valve, be sure that the actuator operates in the desired direction of rotation when pressurized and both actuator / valve are in the correct position.

Important: when using a spring return actuator for a fail safe operation, ensure that when air or electricity failure occurs the direction of rotation is correct for your application.

Fit the actuator 3 onto the valve 5. It is possible to assemble the valve onto the actuator in two ways:

- Direct-mount: fit the stem of the valve 5 directly into the female connection of the actuator 3 and bolt together through the valve ISO pad (max. tightening torque see table).
- Bracket-mount: mounting with a bracket 6 and coupling 7, the bracket is bolted to the actuator / valve to join them together and the coupling is used to connect the actuator output drive to the valve stem (max. tightening torque see table).

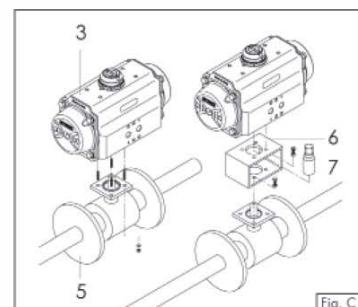

Fig. C

6. MAINTENANCE INSTRUCTION

With the information given below, BSA Armaturen provides the end user with all the required information necessary for maintenance. Under normal conditions, the actuator requires only periodic observation to ensure proper operation.

Maintenance (disassembly, maintenance and rebuilding) of BSA Armaturen actuators is allowed only to BSA personnel or properly instructed personnel. In case of controversy the product guarantee will expire! Spare kits for maintenance are available to replace all seals and bearings (soft parts indicated into the table), that may be necessary between 300.000 and 1.000.000 cycles depending on operating and environmental conditions and actuator size.

6.1 DRAWING WITH ITEMIZED COMPONENTS AND RECOMMENDED SPARE PARTS

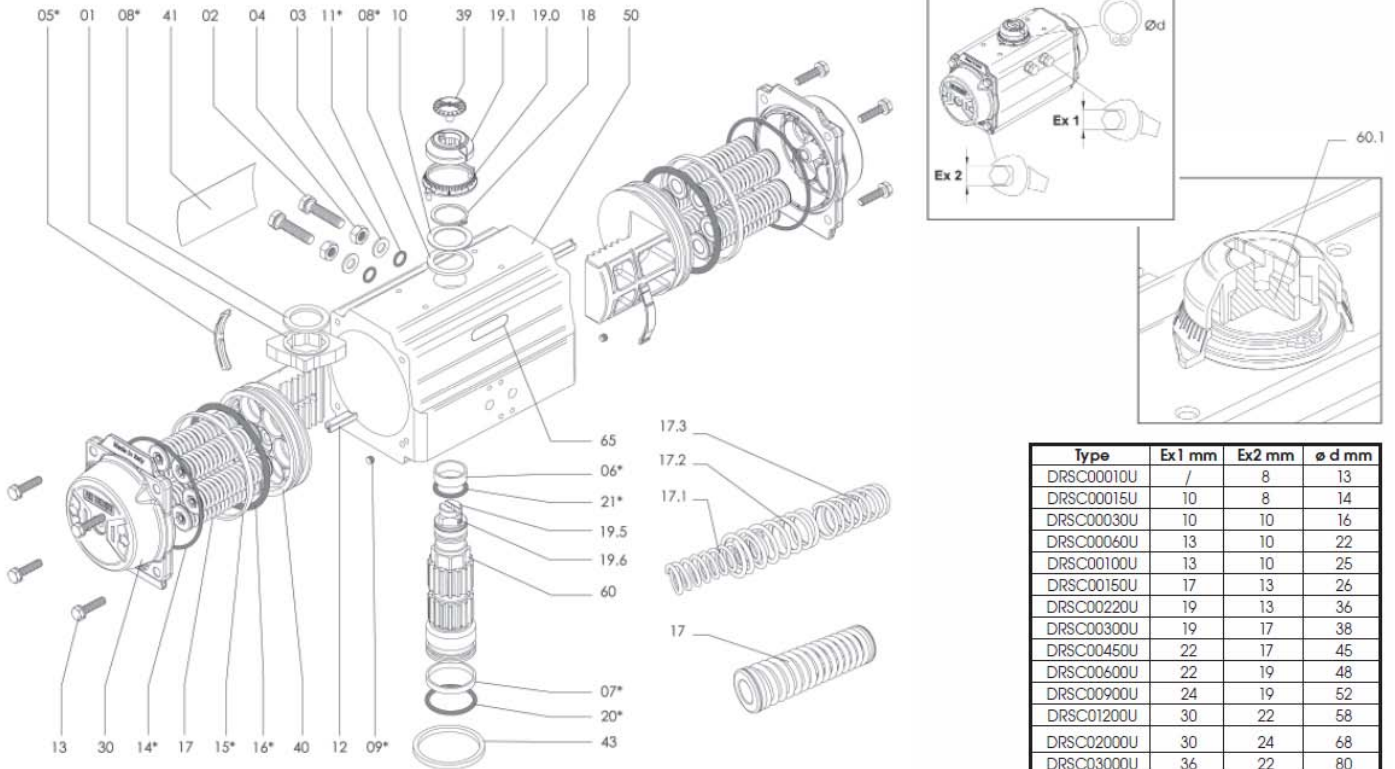

Part	Quantity	Note	Part Description
1	1	not for DRSC00010U	OCTI-CAM (Stop arrangement)
2	1	not for DRSC00010U	Stop cap screw
3	2	not for DRSC00010U	Washer
4	2	not for DRSC00010U	Nut (Stop screw)
05*	2		Bearing (Piston back)
06*	1		Bearing (Pinion top)
07*	1		Bearing (Pinion bottom)
08*	2	1 piece for DRSC00010U	Thrust bearing (Pinion)
09*	2	not for DRSC05000U	Plug
09.1*	2		O-Ring for DRSC05000U
10	1		Thrust washer (Pinion)
11*	2	not for DRSC00010U	O-Ring (Stop screw)
12	2	not for DRSC00010U	Piston guide
13	8/12/16	(A)	Cap screw (End cap)
14*	2		O-Ring (End cap)
15*	2		Bearing (Piston head)
16*	2		O-Ring (Piston)
17	min.5/max.12	for DRSC00030U-DRSC05000U	Spring (Cartridge)
17.1	max.2	not for DRSC00030U-DRSC05000U	Spring for DRSC00010U + 00015U
17.2	max.2	not for DRSC00030U-DRSC05000U	Spring for DRSC00010U + 00015U

Part	Quantity	Note	Part Description
17.3	max.2	not for DRSC00030U-DRSC05000U	Spring for DRSC00010U and DRSC00015U
18	1		Spring clip (Pinion)
19	1	not for DRSC00010U	Position indicator for DRSC00015U + 00030U
19.0	1		Graduated ring
19.1	1	not for DRSC00015U-DRSC00030U	Position indicator
19.5	1	not for DRSC00010U-DRSC00030U	Top adaptor
19.6	2	not for DRSC00010U-DRSC00030U	Hex. socket screw (Top adaptor)
20*	1		O-Ring (Pinion bottom)
21*	1		O-Ring (Pinion top)
30	2		End cap
39	1		Cap screw (Indicator)
40	2		Piston
41	1		Actuator identification label
42	2		End cap label
43	1		Spigot (only on request)
50	1		Body
60	1		Drive shaft
60.1	1	only for type „E“ and „EC“	Integral drive shaft
65	1		Plastic insert

*Suggested SPARE PARTS for maintenance; Notes: (A) 12 pieces for type DRSC03000U/DRSC04000U, 16 pieces for type DRSC05000U

6.2 DISASSEMBLY

When disassembly of actuator is required for maintenance, firstly remove the actuator from the valve. Before performing any disassembly operations it is important to verify that the actuator is not pressurised.

Always use caution and double check that the ports 2 and 4 are vented and are free from any accessory and/or device. When the actuator is a spring return unit, make sure that the actuator is in the failed position and with pistons completely inwards before disassembling.

A. Removal of position indicator and graduated ring (Part N° 19,19.0,19.1), figure 01:

- Remove cap screw (39) if fitted.
- Lift position indicator (19 or 19.1) off shaft, it may be necessary to pry gently with a screwdriver.
- Lift, if necessary, the graduated ring (19.0) off the body, it may be necessary to pry gently with a screwdriver.

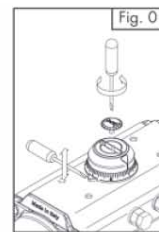

B. Removal of stop cap screws (Part N° 02), figure 02:

- Remove both stop cap screws together with nut (04) and washer (03).
- Remove stop screw o-rings (11) and discard if replacing all soft parts.

C. End caps disassembly (Part N° 30), figure 03:

- End caps disassembly for spring return actuators (disassemble one end cap at a time).
Unscrew the end cap bolts (13) in the sequence shown in figure 03, until the end-caps are free from springs force (for AT045U and AT051U 20-23 turns of the screws, for AT101U to AT801U 4-5 turns of the screws).
Then completely unscrew the screws and remove the end-cap and the springs.

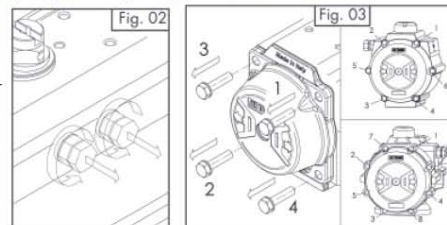

If there is still force on the end-caps after unscrewing as indicated above, this may indicate that spring cartridge is damaged or that the pistons are not completely closed, so any further disassembly should be discontinued.

Further disassembly of the end caps may result in injury.

- End caps disassembly for double acting actuators (disassemble one end cap at a time)
Unscrew the end cap bolts (13) in the sequence shown in figure 03, until the screws are completely unscrewed and the end caps are free.
- Remove the o-rings (14) using a screwdriver. Discard soft parts if replacing.
- Only for actuators with adjustment 50% or 100%, remove the nut 04R, the washers 03R and o-rings 11R and discard soft parts if replacing.

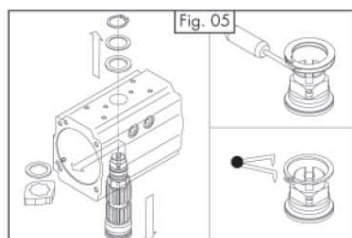

D. Pistons disassembly (Part N° 40), figure 04:

- Holding the body (50) in a vice or similar device, rotate the drive shaft (60) until the pistons (40) are released.
Caution: air pressure should not be used to remove the pistons from the body.
- Remove o-rings (16) using a screwdriver. Remove the piston back (05) and piston head (15) bearings.
- Discard bearings when replacing all soft components.

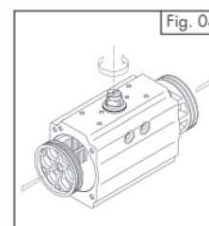

E. Drive shaft disassembly (Part N° 60), figure 05:

- If necessary, remove the graduated ring (19.0) with a screwdriver, remove the spring clip (18) using snap-ring pliers or screwdriver for spiral rings, remove the thrust washer (10) and the external thrust bearing (08).

and the octi-cam (01), then push the pinion (60) completely out of the body. If pinion is not easily removed, gently tap the top of the shaft with a plastic hammer.

- Remove top (06) and bottom (07) pinion bearings and top (20) and bottom (21) pinion o-rings.
- Discard bearings (06) and (07), internal and external thrust washer (08) and o-rings (20) and (21) if replacing the soft components.

All the components disassembled and not replaced will have to be cleaned and inspected for wear and before reassembly, if necessary, also replace the plugs (09).

6.3 ASSEMBLY:

Prior to assembly, ensure that:

- all the components are perfectly clean and in good condition.
- the spare parts and the lubricant used are suitable for the operating temperature of the actuator (see BSA technical data sheets).
- Note: The lubricants suitable for the various operating temperatures (Standard, HT and LLT actuators) are available in BSA Armaturen
Only for "standard" actuators, for temperature from -40°C (-40°F) to +80°C (+176°F), it is possible to use lubricant Dow Corning type Molykote® G-2003.

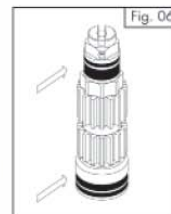

A. Drive shaft assembly (Part N° 60), figures 06, 07 and 07A:

- Install top (06) and bottom (07) bearings, grease and insert the bottom (20) and top (21) pinion o-rings onto the shaft.
- Grease the outside surface of the drive shaft as shown in figure 06.
- Insert partially the drive shaft (60) in the body (50), install octi-cam (01) in the correct position (for standard assembly or for lock-out) as shown in figures 07 and 07A, related to the bottom and top of the drive shaft and the rotation of the actuator when energised. Install the internal thrust bearing (08). Insert completely the drive shaft in the body.
- Fit external thrust bearing (08), thrust washer (10) and then external spring clip (18) using snap ring pliers or screwdriver for spiral rings.

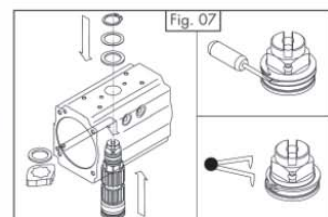

B. Pistons assembly (Part N° 40), figures 08, 09, 10 and 11:

- Grease and install o-rings (16), piston back (05) and piston head (15) bearings.
- Grease the internal surface of the body (50) and the piston (40) rack teeth.
- Insert the female connection of the drive shaft (60) in a properly fixed coupling.
- Ensure that the octi-cam is in the right position as shown in figure 09.
- For standard rotation assembly type "ST" (clockwise to close), rotate the body (50) about 40-45° clockwise from top view, as shown in figure 10.
- Insert and press the two pistons (40) simultaneously inside the body (50) until the pistons are engaged, then rotate the body anticlockwise from top view until the stroke is completed.
- Ensure that with pistons completely closed, the rotation obtained referred to the axis of the body is about over 0° for models AT051U - AT801U (0,5° over 0° for AT045U) and that the dimension "A" on both sides is the same as shown in figure 11.

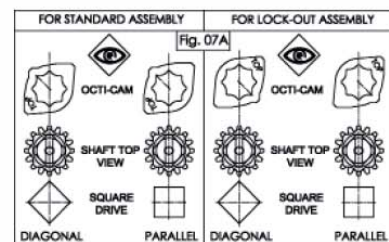

pneum._Antrieb_DR-SC-ENG_2017_Rev.0

C. End cap (Part N° 30) assembly, figures 12, 13 and 14:

- Assemble one end cap at a time.
- Lubricate the body.
- For spring return actuators, insert the springs in each end cap according to the desired configuration, as shown in figure 12 and related tables. For models DRSC00030U -> DRSC5000U insert spring cartridges as shown in figure 13.
- Fit end cap o-ring seal (14) into the groove on both end caps.
- Fit end caps onto the body (50), verifying that the o-ring remains in the groove.
- Only for actuators with 50% or 100% stroke adjustment, ensure that the adjustment screws 221G/222G are completely screwed into the end-cap.
- Insert the cap screws (13) and tighten each only partially. Complete tightening by making 1-2 turns for each screw in the sequence shown in figure 14 until tightening is completed. See the table for screw tightening torque.

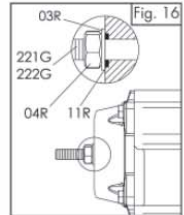
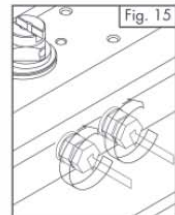
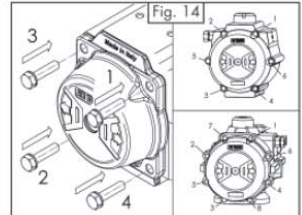
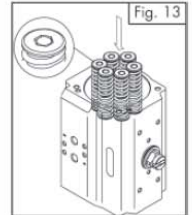
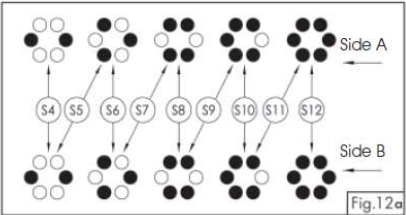
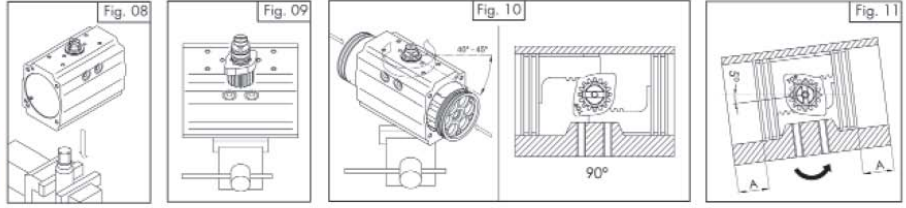

D. Assembly of stop cap screws (Part 02) and stroke adjustment for models DRSC00015U -> DRSC5000U, figures 15 and 16:

- Fit the stop cap screws (02) in the body.
- Stroke adjustment for actuators with standard type "ST" rotation / assembly (clockwise to close).
Stroke adjustment in close position: with the actuator in close position 0°, screw or unscrew the right (from top view) stop cap screw until the desired stop position is achieved. Then tighten the stop adjustment nut (04) to lock it in place.
Stroke adjustment in open position: with the actuator in open position 90°, screw or unscrew the left (from top view) stop cap screw until the desired stop position is achieved. Then tighten the stop adjustment nut (04) to lock it in place.
- For spring return actuators, it could be necessary to make rotation tests to verify the correct stroke adjustment in open position.
- Only for actuators with adjustment 50% or 100%, fit on end-cap adjustment screws 221G/222G the o-rings 11R, the washers 03R and the nuts 04R.
To adjust the stroke in open position: with the actuator in partially or totally open position, screw or unscrew the end-cap adjustment screw 221G/222G until the desired position is achieved.
It is important that the two end-cap adjustment screws are both in contact with the pistons. Then lock the nuts 04R.

E. Assembly of graduated ring and position indicator (Part N° 19,19.0,19.1), figures 17,18 and 19:

- Fix the graduated ring (19.0) to the body.
- If necessary, correctly position the "Top Adaptor" (19.5) and lock it with the proper screws (19.6).
- Insert the indicator (19 or 19.1) making sure that it indicates the correct actuator position.
- Screw the indicator screw (39) if assembled.

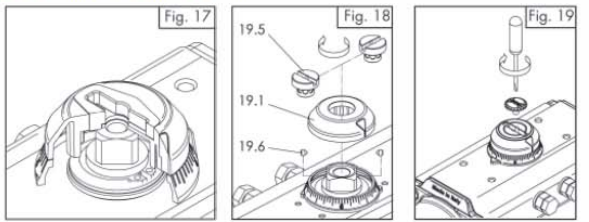

Spring set configuration of SC/SO00010U and SC/SC00015U:

Tab.01: Spring set configuration DRSC00010U

Spring Set	Side B	Side A
	DRSC00010U Spring type	DRSC00010U Spring type
S1-1	1 (green)	1 (green)
S1-2	1 (green)	2 (red)
S2-2	2 (red)	2 (red)
S2-3	2 (red)	3 (black)
S3-3	3 (black)	3 (black)

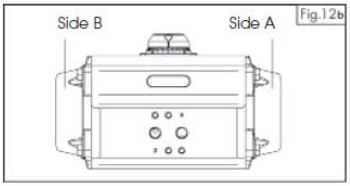

Tab.02: Spring set configuration DRSC00015U

Spring Set	Side B		Side A	
	DRSC00015U Internal spring type	DRSC00015U External spring type	DRSC00015U Internal spring type	DRSC00015U External spring type
S1	1 (green)	—	—	2 (black)
S2	—	2 (black)	—	2 (black)
S3	—	2 (black)	—	3 (red)
S4	—	3 (red)	—	3 (red)
S5	—	3 (red)	1 (green)	2 (black)
S6	1 (green)	2 (black)	1 (green)	2 (black)
S7	1 (green)	2 (black)	1 (green)	3 (red)
S8	1 (green)	3 (red)	1 (green)	3 (red)

7. STORAGE INSTRUCTIONS

If the actuator is not for immediate use, the following precaution must be taken for storage:

- Store the actuator in a clean and dry environment and at temperature between -20°C (-4°F) and +40°C (+104°F).
- It is recommended that the actuator be stored in its original box.
- Do not remove the plastic plugs on air supply ports.

8. LIFTING and HANDLING

It is recommended to lift the actuators with proper, adequate and permitted systems in relation to the actuator weight and by following the ruling laws in terms of safety and health protection. The weight of the actuators is indicated on the BSA catalogue and on the related technical data-sheets. During the lifting and the handling of the actuators, it is recommended to avoid clashes and/or accidental falls in order to avoid irreparable damages to the actuators and to compromise the functionality. Contact Air Torque for any information and technical data-sheets.

9. NOTES regarding the FLANGE CONNECTION

Extract from the standard DIN ISO 5211:
The torque values in the following table show the maximum torques which are allowed to be transmitted by the flange connection:

Flange	Md max.all. (Nm)	Flange	Md max.all. (Nm)	Flange	Md max.all. (Nm)
F03	32	F10	500	F25	8 000
F04	63	F12	1 000	F30	16 000
F05	125	F14	2 000		
F07	250	F16	4 000		

pneum._Antrieb_DR-SC-ENG_2017_Rev.0